

ADL100-ET



General

ADL100-ET single phase electric meter is designed for single phase active energy measurement on low voltage system. The meter meet the related technical requirements of electronic power meter in the IEC62053-21、IEC62053-22 standards.

Product Functions

Function	Description	Provide
Measurement of kWh	Single-phase active kWh (positive and negative)	■
Measurement of electrical parameters	U、I、P、Q、S、PF、Hz	■
LCD Display	8 digits	■
Button	3 keys	■
Pulse output	Active energy pulse output	■
Communication	RS485, MODBUS-RTU	□ C
	Infrared	■

Note:(■: standard; □: optional)

Technical Parameter

■ Electric performance

Voltage	Reference voltage	220V
	Reference frequency	50Hz
	Consumption	<10VA (Single phase)
Current	Maximum current	60A
	Starting current	0.004Ib
	Consumption	<4VA (Maximum current)
Measurement performance	Standards compliant	IEC 62053-21:2003
	Accuracy of Active kWh	Class 1
Pulse	Pulse width	80±20ms
	Pulse constant	1600imp/kWh

■ Working environment

Temperature	Operating	-25℃~55℃
	Storage	-40℃~70℃
Humidity	≤95%(No condensation)	
Altitude	<2000m	

Dimension drawings (Unit: mm)

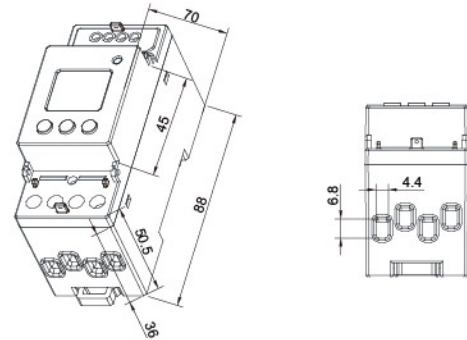

Note: The torque should not be greater than 2.0N·m

■ Wiring

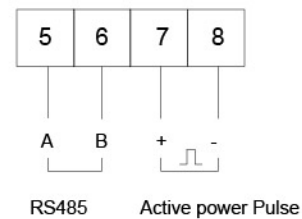
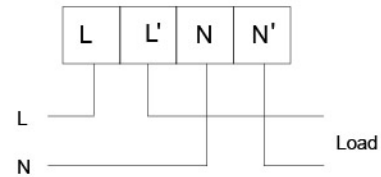

10(60)A specification wiring diagram

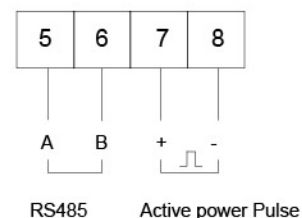
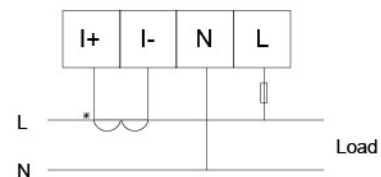

20(100)A specification wiring diagram

■ Installing



ADL100-ET installing

Note: Note: DIN 35 mm rail installation.

Operation and display

■ Key description

Key icon	Key name	Key function
	Menu	Enter/quit, save
	Up	Flash bit change
	Down	Flash bit right-ward/next page

■ Display examples

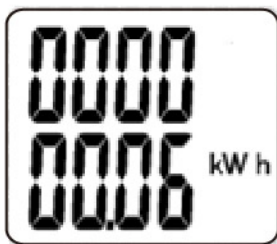

(1) Total active energy



(2) Voltage



(3) Current

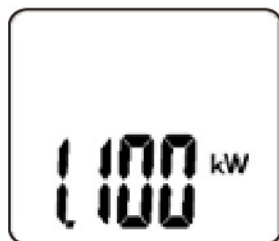

(4) Active power

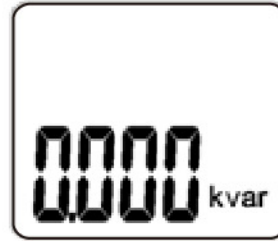

(5) Reactive power

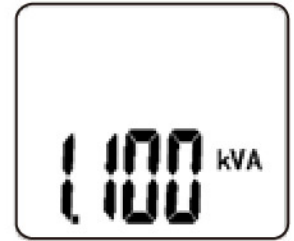

(6) Apparent

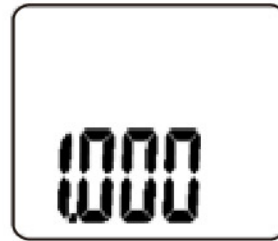

(7) Power factor



(8) Frequency



(9) Firmware Version

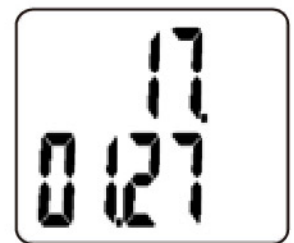

(10) Date

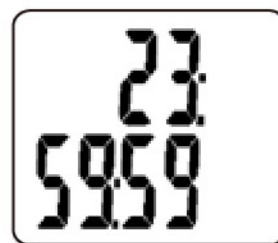

(11) Time

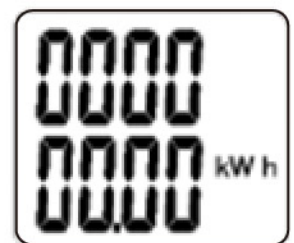

(12) Spike energy

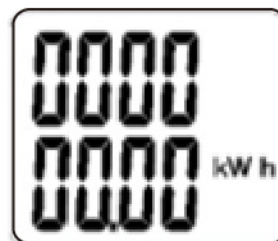

(13) Peak energy

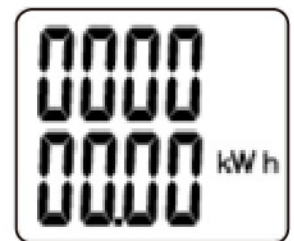

(14) Flat energy

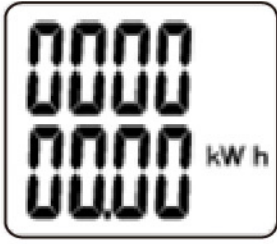

(15) Valley energy

■ Programming display menu

Press at any main menu and get in interface, and then press show , and enter the code. If you enter a wrong code, it will show and back to main menu; and if you enter a right code, you can set the parameter. After setting the parameter, it will show and save the change by pressing and quit without save by pressing .

■ Item can be set

Number	Firstly Menu		Secondly menu		
	Symbol	Meaning	Symbol	Meaning	Range
1		Code		Set code	0000-9999
2		protocol		Set protocol	Mod-Modbus
3		modbus		Set address (modbus)	1-247
4		Baud rate		Set baud rate	9600、4800、2400、1200
5		Parity method		Set parity method	None/Even
6		Save		Save page	No/Yes

Note: is Modbus